

# CP02-Series

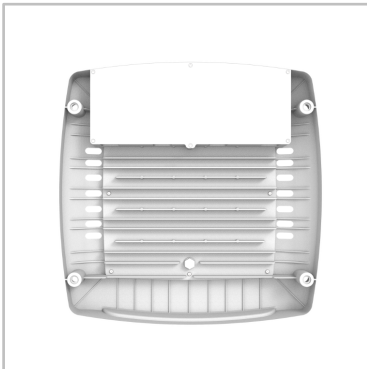

## KEY ADVANTAGES

- The aluminum heat sink hole design on the back enhances the air convection area and achieves high-quality heat dissipation
- High lumen LED chip, up to 150LM, with stable light emission and low light decay
- Support plug-and-play sensor optional, provide protection for intelligent lamps
- Features of low glare, uniform light color and high color rendering, matching a variety of professional light distribution, suitable for a variety of applications
- Sealed, dustproof and waterproof, effectively facing outdoor weather
- Easy to maintenance, which achieves to reduce labor cost

## TYPES OF APPLICATION

- GAS STATION
- LEISURE AREA
- CAR PARKS
- RAILWAY STATIONS& METROS



GAS STATION



LEISURE AREA



CAR PARKS



RAILWAY STATIONS& METROS



## GENERAL INFORMATION

Driver included	Yes
CE mark	Yes
RoHS compliant	Yes
Safety features	Open circuit protection Short circuit protection Overvoltage protection
Testing standard	LM-79 -19 (all measurements in ISO17025 accredited laboratory)

## HOUSING AND FINISH

Housing	Aluminium
Optic	Polycarbonate
Protector	Glass
Glass	Tempered glass
Respirator	Yes
Housing finish	Electrostatic polyester powder coating
Standard colour(s)	RAL 1127 white
Tightness level	IP 66
Impact resistance	IK 07

## OPERATING CONDITIONS

Operating temperature range (Ta)	-30°C to + 45°C
Operating Humidity	10-90%RH
Mounting Option	Ceiling mount
Warranty	5 years

## PERFORMANCE

Power	75W/100W/ 120W/150W
Efficacy	150lm/W,130lm/W
Power Efficiency	≥86%
Start Time	≤0.2S

## ELECTRICAL INFORMATION

Electrical class	Class I EU
Nominal voltage	120-277V   50/60Hz
Power factor (at full load)	0.9
Surge protection options (kV)	6KV-Line-Line 6KV-Line-Earth
Electromagnetic compatibility (EMC)	EN 55015:2019/A11:2020, EN 61000 3-2:2019, EN 61000-3-3:2013, EN 61547:2009, EN 62493:2015
Control protocol(s)	1-10V, DALI2 (optional)
Sensor	Motion sensor (optional)
Total Harmonic Distortion(THD)	IEC 61000-3-2 Class C <20%
Driver Type	Constant current(CC)
Filcker	No
withstand voltage	1.5KV 60S 10mA

※ Lamp switch must control L line or control L and N lines.

## OPTICAL INFORMATION

LED Type	SMD2835
Beam Angle	60° / 90° / 120°
Recommended installation height	4m to 15m
Color Tolerance	Ra70 ≤7 Ra80 ≤5
LED colour temperature	3000K / 4000K / 5000K / 5700K / 6500K
Colour rendering index (CRI)	CRI>70 standard CRI>80 optional
Upward Light Output Ratio (ULOR)	0%

※ Ra measurement tolerance is ±2.

## LIFETIME OF THE LEDS @ TA 25°C

All configurations	
L70B10	>100,000h
L80B10	>50,000h
L90B10	>30,000h
Switching Cycles	>100,000 times

## STANDARD VERSION

POWER	LUMENS	EFFICACY
75W	11,250LM	150LM/W(Ra70)
	10,500LM	140LM/W(Ra80)
100W	15,000LM	150LM/W(Ra70)
	14,000LM	140LM/W(Ra80)
120W	18,000LM	150LM/W(Ra70)
	16,800LM	140LM/W(Ra80)
150W	22,500LM	150LM/W(Ra70)
	21,000LM	140LM/W(Ra80)

## ECO VERSION

POWER	LUMENS	EFFICACY
75W	9,750LM	130LM/W(Ra70)
	9,000LM	120LM/W(Ra80)
100W	13,000LM	130LM/W(Ra70)
	12,000LM	120LM/W(Ra80)
120W	15,600LM	130LM/W(Ra70)
	14,400LM	120LM/W(Ra80)
150W	19,500LM	130LM/W(Ra70)
	18,000LM	120LM/W(Ra80)

※The Performance Data is tested base on 230VAC, 90° and 4000K for all versions  
 ※Power Consumption Tolerance  $\pm 5\%$  (Apply to all versions)  
 ※Lumen Efficiency Tolerance  $\pm 5\%$  (Apply to all versions)

PACKAGING

POWER	PACKAGE SIZE	QTY/CTN	SINGLE PIECE VOLUME	NET WEIGHT	GROSS WEIGHT	20GP	40HQ
75W	L460*W460*H130mm	1PCS/CTN	0.0275m <sup>3</sup>	4.4kg	5.2kg	1173pcs	2717pcs
100W	L460*W460*H130mm	1PCS/CTN	0.0275m <sup>3</sup>	4.5kg	5.3kg	1173pcs	2717pcs
120W	L460*W460*H130mm	1PCS/CTN	0.0275m <sup>3</sup>	4.5kg	5.3kg	1173pcs	2717pcs
150W	L460*W460*H130mm	1PCS/CTN	0.0275m <sup>3</sup>	4.6kg	5.4kg	1173pcs	2717pcs

1173<sup>PCS</sup>  
75W/20GP

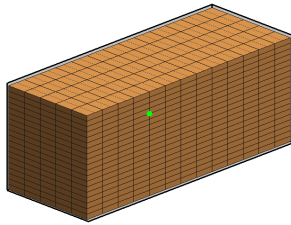

2717<sup>PCS</sup>  
75W/40HQ

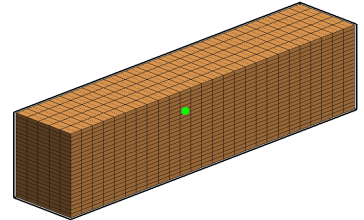

1173<sup>PCS</sup>  
100W/20GP

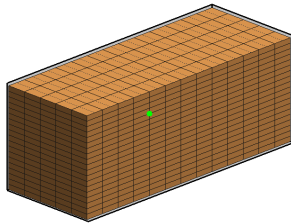

2717<sup>PCS</sup>  
100W/40HQ

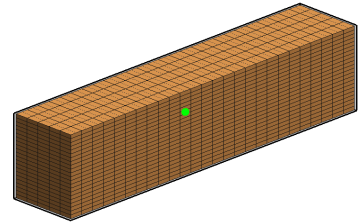

1173<sup>PCS</sup>  
120W/20GP

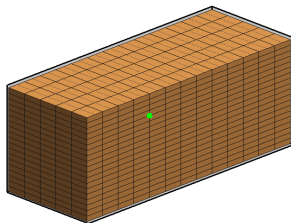

2717<sup>PCS</sup>  
120W/40HQ

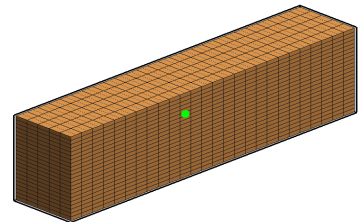

1173<sup>PCS</sup>  
150W/20GP

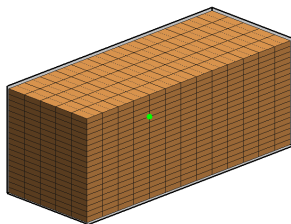

2717<sup>PCS</sup>  
150W/40HQ

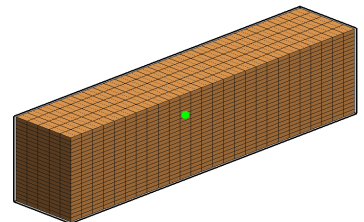

## LIGHT DISTRIBUTIONS

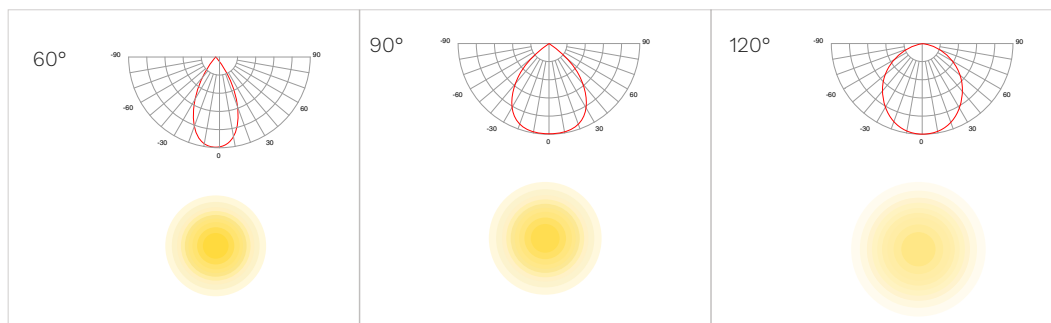

## OPTIONAL ACCESSORIES

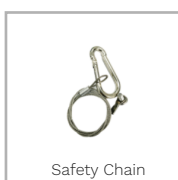
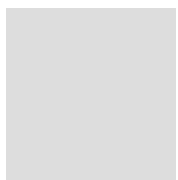
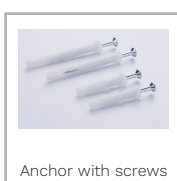
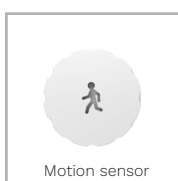
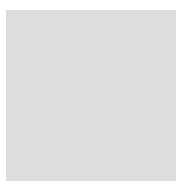

75W/100W

120W/150W

